

ALYSIUM PRODUCT DOCUMENT SPECIFICATION PACK

This Document Pack is for the Specification:

A74-6659[1].001 **X** **Validated 29/07/2019 08:09:00**

Which comprises of the following SubComponents:

Electrical Testing

ETR 0901.002	X	Validated	20/10/2016 02:03:00	ETR 0901.002.pdf	1
ETE 0900	00	Validated	26/04/2016 03:00:00		

Manufacturing Process

LPR 0001(USB 3 AM-B).000	X	-		LPR 0001(USB 3 AM-B).000.pdf	1
Label on Bag (ALY CE)	00	-		Alysium CE.pdf	1
Label on Cable (Pad Print WHT)	00	-		Alysium CE.pdf	1

USB Assembly

P74-6659[1].000	X	Validated	21/09/2017 04:40:00	P74-6659.000.pdf	1
A86-4730(T)	01	Validated	05/03/2019 07:27:00	A86-4730(T)(01).pdf	1
USB A 3.0 (OD5.8 DCT)	01	Validated	25/06/2018 00:37:00	USB A 3.0 (OD5.8 mh Threaded).pdf	1
A99-7117	00	-			
USB A 3.0 s1 Bracket	00	-		USB A 3.0 s1 Bracket.pdf	1
USB B 3.0 (DC) Bracket	00	-			
USB B 3.0(OD5.8 DCT)	00	-		USB B 3.0 (OD5.8 MH Threaded).pdf	1
A99-9751	00	-			

Electrical Test Criteria

- 1) Open/Short circuit
- 2) Intermittent
- 3) Insulation Resistance

Hi Pot Tester Model

CT-8681N (ATPN : ETE 0900)

Measurement Parameters

Voltage = 300VDC,

Insulation Resistance > 20M Ohm,

Time = 0.1s

Sampling size

100% Check

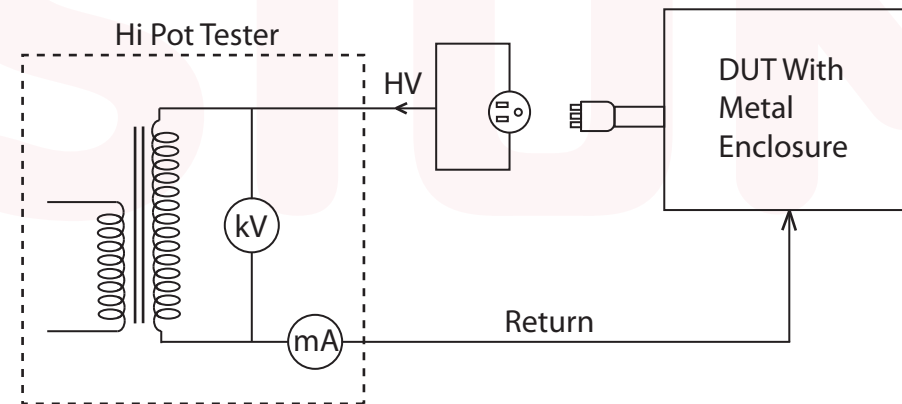

Simulated Line Leakage Diagram



Heat Sealed PE Bag Packaging

Cable Assembly Example:

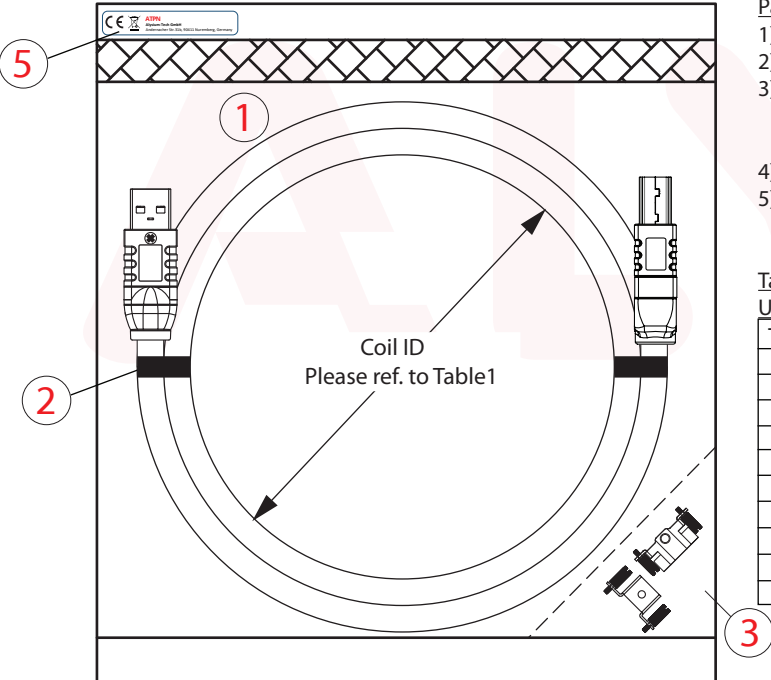

Packaging Content:

- 1) Basic Assembly x1
- 2) Magic Tie/ Cable Tie x2
- 3) Accessories
 - USB A 2.0/ 3.0
 - USB B 2.0/ 3.0
- 4) White Pad Print on Cable
 - Locking Bracket x1 + Thumbscrew x2 + Flat head Screw x1
 - Locking Bracket x1 + Thumbscrew x2 + Flat head Screw x1
- 5) Label On Bag (ALY CE)

Table 1: Assembly Coiling Inner Diameter Unless Otherwise Specified

Type of Cable [Jacket OD(mm)]	Coil ID (mm)
Default	150
MCD-USB-211[7.3]	250
MCD-USB-213[7.4]	250
MCD-USB-209B[7.4]	250
A87-3502[9.45]	250

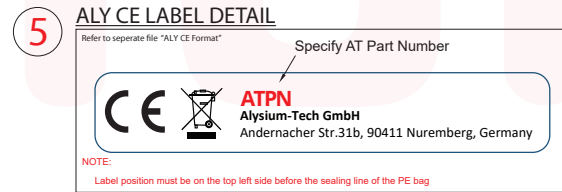

Cable Label Guideline

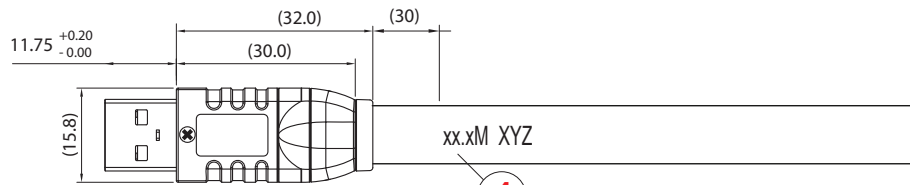

4 PAD PRINT <WHITE>

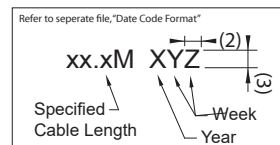



DRAWING REF: **P74-6659.000**

DRAWING REF: USB 3.0 Industrial Assembly (A+ series)

(WON 170920)

Initial Issue

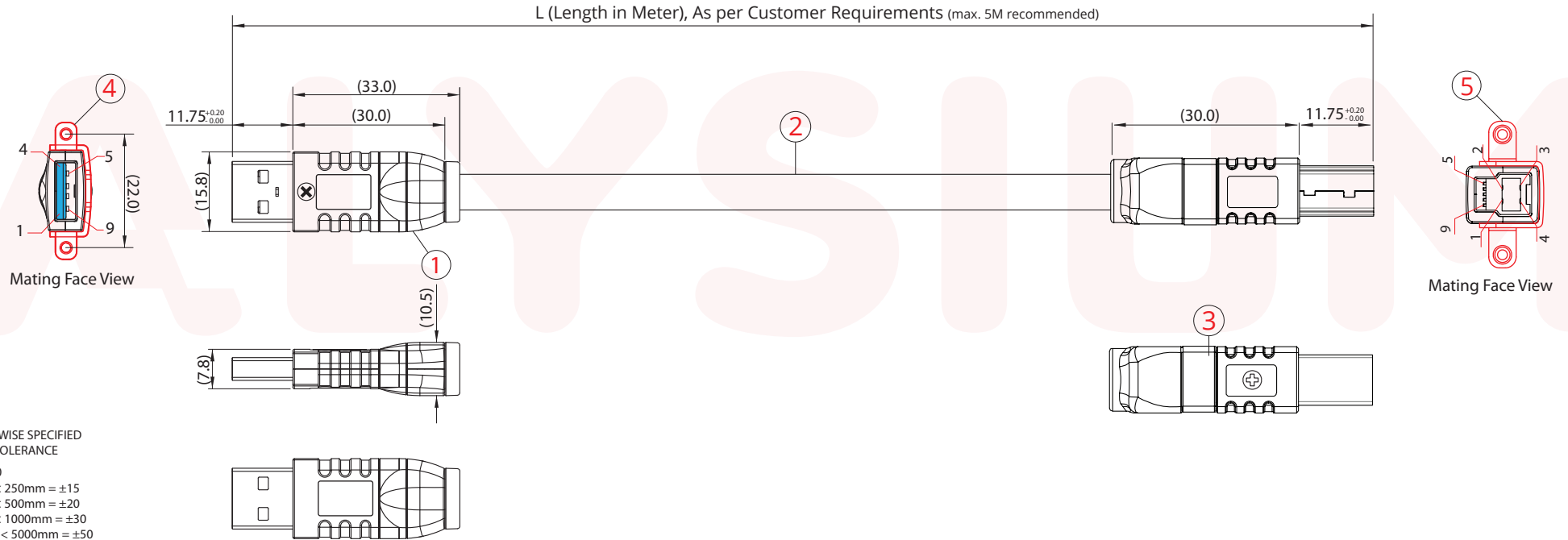

UNLESS OTHERWISE SPECIFIED
 ASSY LENGTH TOLERANCE
 < 150mm = ±10
 ≥ 150mm and < 250mm = ±15
 ≥ 250mm and < 500mm = ±20
 ≥ 500mm and < 1000mm = ±30
 ≥ 1000mm and < 5000mm = ±50
 5000mm and above = ±100

RoHS COMPLIANT

This document is the property of Alysium-Tech. It must not be copied or otherwise disclosed without prior written consent

ALYSIUM

BILL OF MATERIALS

Item	Description
1	A+ USB A 3.0 (OD5.8 Die Cast Threaded) Die Cast Shell
2	A86-4730(T), [OD=6.2mm] <BLK> E357566-ALY UL2725 2STP#26 + 1P#28 + 2C#22
3	A+ USB B 3.0 (OD5.8 Die Cast) Die Cast Shell
4	USB A 3.0 (Die Cast) sl Bracket (Refer to Accessories Details)
5	USB B 3.0 (Die Cast) sl Bracket (Refer to Accessories Details)

WIRING DIAGRAM

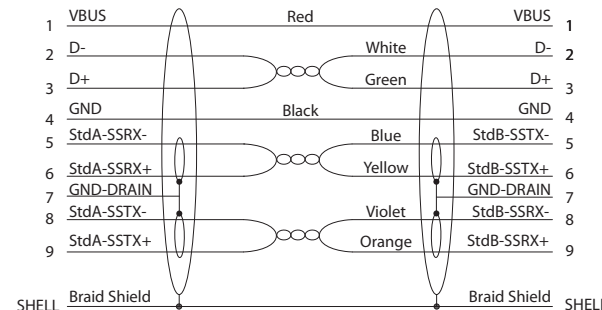

ACCESSORIES DETAILS

This Assembly/ Item ④ inclusive of accessories as per below shown:
 A) Metal Sheet Bracket for USB A 3.0 (1pcs) & USB B 3.0 (1pcs)
 B) M2 Thumb Screw (2pcs)
 C) M2.6x3.0 Flat Head Screw (Pre-Installed in Metal Sheet Bracket) ① (1pc)

